

CATALOG ²⁰¹⁷ DE PREȚURI

PENTRU **ACCESORII, DISPOZITIVE,**
PIESE DE SCHIMB ORIGINALE
ȘI LĂMPI DE ILUMINAT LOCAL

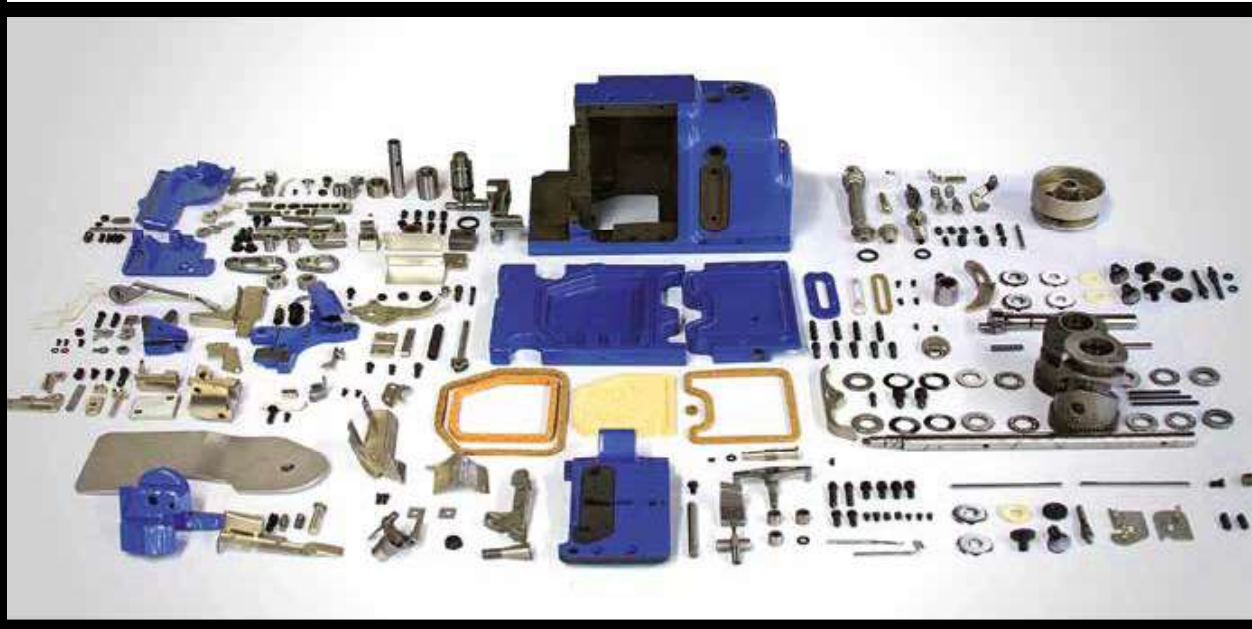

ASS BARUDAN BATTISTELLA BROTHER BS CCEA
CERLIANI COMPLETT EFKA HIROSE HOOKS JUKI
KANSAI SPECIAL MAIER UNITAS MERROW
PEGASUS RELIANT SIRUBA YAMATO Z LASER

Livrăm la comandă și din stoc (peste **100.000** de repere) piese originale pentru următoarele mărci de mașini:



BROTHER - Mașini industriale de cusut și brodat

<http://partsbook.brother.co.jp/partsnavi/eng/index.html>



PEGASUS - Mașini de surfilat, de acoperire, cusătură lanț

<http://www.pegasus-europa.de/pp-catalogues.htm>



KANSAI SPECIAL - Mașini cusătură lanț, special, multi-ace

<http://www.kansai-special.de/Home/index.php/>

<http://www.kansai-special.co.uk>

http://www.kansai-special.com/english/prod/prod_info.html



BARUDAN - Mașini industriale de brodat

<http://barudan.fr/en/> <http://barudan.fr/en/telechargements/>



A-S-S AUTOMATIC SEWING SYSTEMS - Automate de coasere

http://assag.de/start_eng



MAIER UNITAS - Mașini de cusut ștafir și piese de schimb

<http://www.maier-unitas.de/95-1-Rumaenien.html>



COMPLETT - Ketturi și mașini cusătură punct manual

<http://complett.it/en/index.html>

ALTE MĂRCI: **BATTISTELLA** BS **CCEA** CERLIANI **EFKA** HIROSE HOOKS
JUKI MERROW **RELIANT** SIRUBA **YAMATO** Z LASER

PIESE DE SCHIMB: Carmen **MAIL:** piese@brorom.ro **TELEFON:** (+4) 0751-020.959

www.brorom.ro

Lista de preturi

PICIORUSE SI DISPOZITIVE PENTRU MASINA DE CUSUT LINIARA CU 1 AC CUSATURA RIGIDA (B700)	3
Picioarse compensatoare	3
Picioarse de fermoar.....	4
<i>Picioarse de fermoar pentru masina cu transport la ac</i>	6
<i>Picioarse de fermoar ascuns</i>	6
Picioarse pentru tighelire.....	8
Picioarse de incretire	10
Picioarse de matlasare	12
Picioarse de aplicat benzi, snururi si elastic.....	13
Picioarse speciale	16
Picioarse de teflon	17
Picioarse pentru masina cu transport la ac	19
Dispozitive de passpoil.....	20
Dispozitive pentru tivuri.....	21
Dispozitive pentru aplicat vipusca si snur	25
Dispozitive tip “Spaghetti”	25
Limitatoare	26
Accesorii.....	27
MASINA DE CUSUT TIP UBERDECK (B271, 272)	28
MASINA DE CUSUT CU 2 ACE CUSATURA RIGIDA (B842, B845)	31
MASINA DE CUSUT CU BRAT PENTRU CUSATURA FRANTUZEASCA (B927)	32
MASINA CU 4 ACE PENTRU BETELIE (B281)	32
MASINA DE SURFILAT (SERIA N)	32
Ace de cusut Groz-Beckert.....	33
Ulei pentru masini de cusut.....	34
Consumabile pentru sala de CROIT	35
Lame bandzig diferite dimensiuni	35
Cutite verticale si cutite circulare	35
Origine Germania, Producator BS si Maier Unitas	35
Piese de schimb si consumabile pentru mese de calcat si generatoare	36
Lampi de iluminat local cu LED	40
LASERE	41

BRO ROM INDUSTRIAL MACHINES SRL

BUCURESTI, 050826, Str. Uranus nr. 150-The Ark, etaj 3, sector 5

telefon/fax: 021-2323872; 021-2323844; 021-2323969

Mobil: 0751-888.444

BANCA TRANSILVANIA, RO46BTRL04501202846478XX

RO9645361, J40/5796/1997, Capital social 10.000 Lei

www.brorom.ro ■ www.cusutsibrodat.ro

Contact departamente:

Piese de schimb si accesorii:

Carmen 0751-020.959

piese@brorom.ro

Masini industriale:

Bogdan 0722-349.990

office@brorom.ro

Masini casnice de cusut si brodat





Dan 0722-293.132

info@CusutsiBrodat.ro

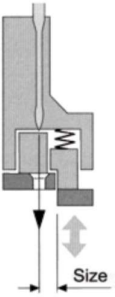

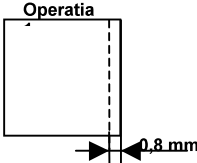
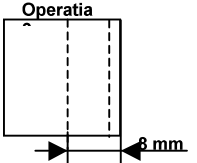

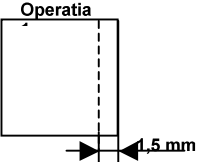
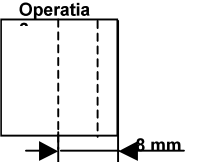
Picioruse si dispozitive pentru masina de cusut liniara cu 1 ac cusatura rigida (B700)

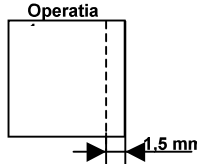
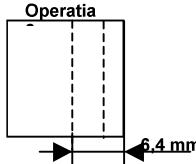
Picioruse compensatoare

cod	denumire		Pret € + TVA	
CL-inch	PICIORUS COMPENSA TOR (pe stinga) in inch	PICIORUS COMPENSA TOR (pe stinga)		
	sau	1 mm 1,5 mm 2 mm 2,5 mm 3 mm 4 mm 5 mm 6 mm 7 mm 8 mm 9 mm 10 mm		
CL-mm	1/32" (0,8 mm)	1,5 mm		
	1/16" (1,5 mm)	2 mm		
CR-inch	PICIORUS COMPENSA TOR (pe dreapta)	PICIORUS COMPENSA TOR (pe dreapta):		
	sau	1 mm 1,5 mm 2 mm 2,5 mm 3 mm 4 mm 5 mm 6 mm 7 mm 8 mm 9 mm 10 mm		
CR-mm	1/32" (0,8 mm)	1,5 mm		
	1/16" (1,5 mm)	2 mm		
CD	PICIORUS COMPENSA TOR DUBLU si pe stinga si pe dreapta	PICIORUS COMPENSA TOR DUBLU si pe stinga si pe dreapta		5 €
	sau	0 mm 1 mm 2 mm		
23-14-24	PICIORUS COMPENSATOR DUBLU si pe stinga si pe dreapta			
	1/32" (0,8 mm)x1/4" (6,4 mm) se pot realiza 2 cusaturi cu acelasi piciorus in 2 treceri			

23-15-25	<p>PICIORUS COMPENSATOR DUBLU si pe stinga si pe dreapta 1/32" (0,8 mm)x5/16" (8 mm) se pot realiza 2 cusaturi cu acelasi piciorus in 2 treceri</p>		<p>Operatia</p> 	<p>Operatia</p> 	12 €
231-15-25	<p>PICIORUS COMPENSATOR DUBLU si pe stinga si pe dreapta 1/16" (1,5 mm)x5/16" (8 mm) se pot realiza 2 cusaturi cu acelasi piciorus in 2 treceri</p>		<p>Operatia</p> 	<p>Operatia</p> 	12 €
231-14-24	<p>PICIORUS COMPENSATOR DUBLU si pe stinga si pe dreapta 1/16" (1,5 mm)x1/4 (6,4 mm) se pot realiza 2 cusaturi cu acelasi piciorus in 2 treceri</p>		<p>Operatia</p> 	<p>Operatia</p> 	12 €

Picioruse de fermoar

cod	denumire			Pret € + TVA
P363	<p>PICIORUS FERMOAR UNIVERSAL ingust cu virful ridicat (P363V)</p>			2 €
P301N	<p>PICIORUS INGUST de fermoar pe stinga</p>			2 €

P36L

PICIORUS lat doar pe stinga



2 €

P36N

Piciorus ingust de fermoar



3 €

P36

PICIORUS lat de aplicat fermoar doar pe dreapta



2 €





259635

Piciorus de fermoar pentru masina cu 2 ace distanta intre ace: 1/4 (6,4 mm), 1/8" (3,2 mm) si 3/16" (4,8 mm)



7 €

Picioruse de fermoar pentru masina cu transport la ac

cod	denumire		Pret € + TVA
P363NF	PICIORUS FERMOAR ingust cu virful ridicat pentru masina cu transport la ac cu gaura lunga (P363VNF)		 8 €
P36-NF	PICIORUS fermoar lat doar pe dreapta pentru masina cu transport la ac cu gaura lunga		 8 €
S518N-NF	PICIORUS FERMOAR ASCUNS (invizibil) pentru masina cu transport la ac		8 €

Picioruse de fermoar ascuns

cod	denumire		Pret € + TVA
S518	PICIORUS FERMOAR ASCUNS (invizibil)		3,5 €

S518A

PICIORUS FERMOAR
ASCUNS (invizibil)
REGLABIL



8 €

S518S

PICIORUS FERMOAR
INVIZIBIL RIGID



4 €

S518NE

PICIORUS FERMOAR
ASCUNS (invizibil) cu
virful ascutit



6 €

S518NS

PICIORUS FERMOAR
ASCUNS (invizibil) cu
virful ascutit



4 €

S518NT

PICIORUS FERMOAR
ASCUNS (invizibil) din
TEFLON



2 €

S518P-N PICIORUS INALT pentru
FERMOAR ASCUNS
(invizibil) PLASTIC



1 €

Picioruse pentru tighelire

cod	denumire	Pret € + TVA
-----	----------	--------------

S592 PICIORUS de tighelire canturi
reglabil de la surub pentru latime
intre 0 si 7mm



7 €

S524 PICIORUS cu un limitator dreapta
si unul pe stinga reglabil cu
distanța maxima 25mm



6 €

P81 PICIORUS dreapta cu limitator
reglabil pe dreapta

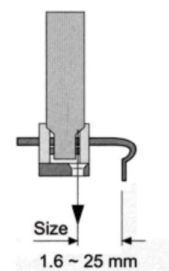

5 €

PICIORUS CU LIMITATOR FIX pe dreapta cu distanta intra ac si limitator de

P810(1/32")	1/32" (0,8mm)
P811(1/16")	1/16" (1,5mm)
P813(3/16")	3/16" (4,8mm)
P814(1/4")	1/4" (6,4mm)

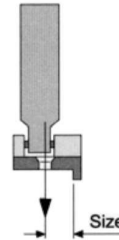

4 €

PICIORUS CU LIMITATOR CANT cu lamela elastica cu distanta dintre ac si limitator:

P10(1/32")	1/32" (0,8mm)
P11(1/16")	1/16" (1,5mm)
P12(1/8")	1/8" (3,2mm)
P13(3/16")	3/16" (4,8mm)
P14(1/4")	1/4" (6,4mm)
P15(5/16")	5/16" (8mm)
P16(3/8")	3/8" (9,5mm)
P18(1/2")	1/2" (12,5mm)

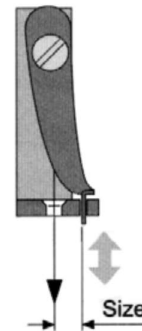

3 €

PICIORUS pe DREAPTA CU LIMITATOR MOBIL INCLUS cu distanta dintre ac si limitator:

SP-18

1/16" (1,5 mm),
1/32" (0,8 mm),
1/4" (6,4 mm),
1/8" (3,2 mm),
3/16" (4,8 mm),
3/32" (2,4 mm)



7 €



PICIORUS pe STINGA CU LIMITATOR MOBIL INCLUS cu distanta dintre ac si limitator:

SP-18L

1/16" (1,5 mm)
1/32" (0,8 mm)
1/4" (6,4 mm)
3/16" (4,8 mm)

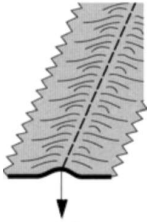

7 €

SM20(1/32")	PICIORUS CU LIMITATOR MOBIL pentru tighelit la 1/32"=0,8mm		12 €
S510	PICIORUS GHIDAJ CENTRAT FIX pentru tighelirea in sant (ascunsa)		8 €
212G-	Piciorus de tighelit canturi pe stanga (cu ghidaj fix) la masina de 2 ace 1/4 (6,4 mm), 1/8" (3,2 mm) si 3/16" (4,8 mm)		7 €
212G-1	Piciorus de tighelit canturi pe dreapta (cu ghidaj fix) la masina de 2 ace 1/4 (6,4 mm), 1/8" (3,2 mm) si 3/16" (4,8 mm)		7 €
Picioruse de incretire			
cod	denumire	Pret € + TVA	
P50	PICIORUS INCRETIRE cu raport constant		5 €
			

P50H

PICIORUS INCRETIRE cu raport constant mic

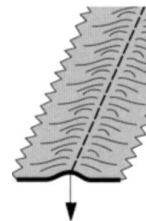

5 €

P50M

PICIORUS INCRETIRE cu raport constant mediu

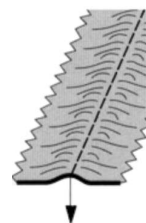

5 €

P50N

PICIORUS INCRETIRE cu raport constant mare

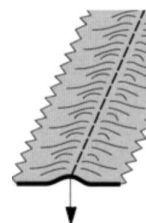

5 €

P5R

PICIORUS INCRETIRE SI ASAMBLARE CU REZERVA DE COASERE 4 mm (volane)

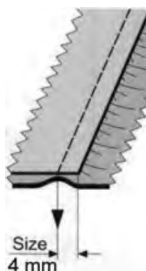

5 €

P950

PICIORUS INCRETIRE REGLABIL cu doua parti interschimbabile

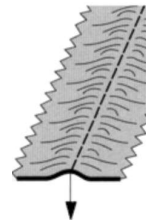

5 €

P5W	PICIORUS INCRETIRE SI ASAMBLARE CU REZERVA DE COASERE 10 mm (volane)			5 €
P952	PICIORUS REGLABIL CU SURUB			5 €

Picioruse de matlasare

cod	denumire			Pret € + TVA
P723	PICIORUS de matlasare cu limitator interschimbabil pe stinga si pe dreapta			6 €
T723	PICIORUS TEFLON de matlasare cu limitator interschimbabil pe stinga si pe dreapta			6 €

P803	PICIORUS MATLASAT cu ghidaj pe dreapta (reglabil 16-25 mm)		5 €
G808	Limitator reglabil pe dreapta cu fixare in surubul piciorusului presor		5 €
			2,15 €

Picioruse de aplicat benzi, snururi si elastic

cod	denumire	Pret € + TVA		
A18-SS	PICIORUS REGLABIL DE APLICAT BANDA			20 €
A225E	PICIORUS REGLABIL DE APLICAT BANDA (maxim 55 mm)			20 €

S533

**PICIORUS REGLABIL DE
APLICAT BANDA cu
ghidaj interschimbabil
pentru latime banda intre:
0 si 30 mm;
0 si 60 mm**

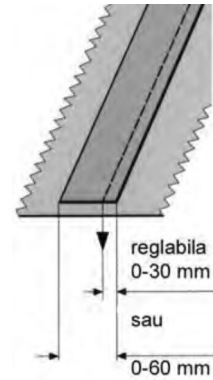

20 €

P312SB

**PICIORUS DE APLICAT
BANDA cu latimea benzii
maxim 12,7mm**

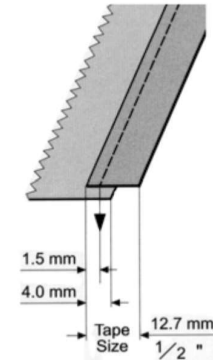

22 €

P3316C

**PICIORUS de aplicat
SNUR cu latimea de
4,8mm cu cusatura pe
centru**

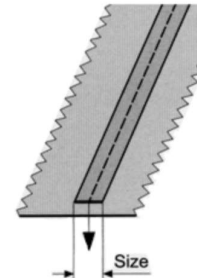

6 €

P3316L

**PICIORUS de aplicat
SNUR cu latimea de
4,8mm cu cusatura pe
stinga**

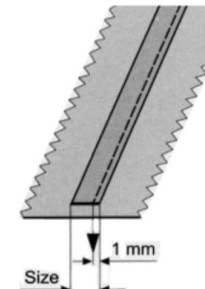

6 €

P3316R

**PICIORUS de aplicat
SNUR cu latimea de
4,8mm cu cusatura pe
dreapta**

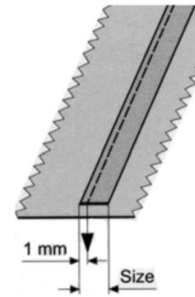

6 €

S10A

**PICIORUS de aplicat snur
cu latimea de :**

1/8" (3,2 mm),
3/16" (4,8 mm),
1/4" (6,4 mm),
5/16" (8 mm),
3/8" (9,5 mm),
7/16" (11,1 mm)
1/2" (12,5 mm)

**Si pozitionarea cusaturii
reglabila de la surub**

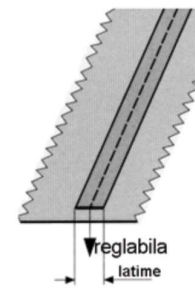

6 €

A227



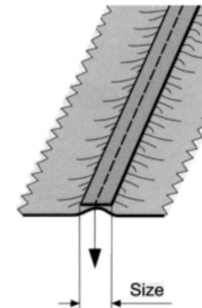

**PICIORUS DE INTRODUS
ELASTIC incretire si
tensionare de la surub**

Laima elasticului	
3,2 mm (1/8")	
4,8mm (3/16")	
6,4mm (1/4")	
8 mm (5/16")	
9,5mm (3/8")	
12,7mm (1/2")	

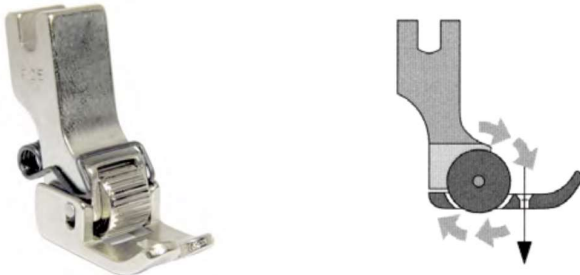

5,5 €

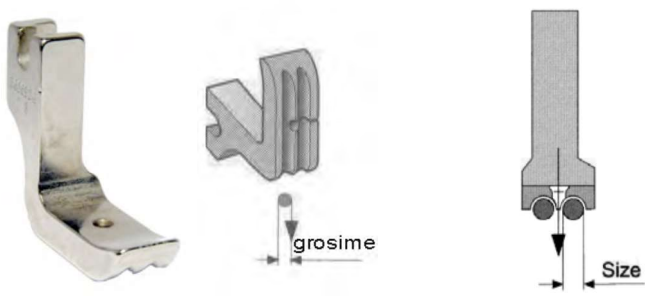
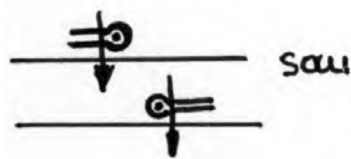
Picioruse speciale

cod	denumire		Pret € + TVA
R2E	PICIORUS CU ROLA INCLUSA pentru materiale dificile		5 €
K1-P	PICIORUS PRESOR CU ROLA pentru materiale dificile		15 €
PICIORUS SNUR DUBLU			
P69D(1/16")	P69R(1/16")		5 €
P69D(1/8")	P69R(1/8")		
P69L(1/16")	1/16" (1,5mm)		
P69L(1/8")	1/8" (3.2mm)		
			
503896N	PICIORUS MASINA de ZIG ZAG pentru aplicat banda cu latime reglabila intre 4,8mm si 18mm		12 €

Picioruse de teflon

cod	denumire	Pret € + TVA
T35	PICIORUS UNIVERSAL cu talpa TEFLON 11mm	2 €
T350	PICIORUS UNIVERSAL CU TALPA TEFLON	2 €
T363	PICIORUS FERMOAR UNIVERSAL TEFLON	1,5 €
T35CW	PICIORUS TEFLON UNIVERSAL	2 €
T36B	TALPA TEFLON REZERVA	1 €



T36L	<p>PICIORUS FERMOAR CU TALPA LATA DOAR PE STINGA DIN TEFLON</p>			3,5 €				
T36LN	<p>PICIORUS FERMOAR CU TALPTA INGUSTA DOAR PE STINGA DIN TEFLON</p>			2,5 €				
T36N	<p>PICIORUS FERMOAR CU TALPTA INGUSTA DOAR PE DREAPTA DIN TEFLON</p>			2,5 €				
TCL	<p>PICIORUS COMPENSATOR DIN TEFLON (STINGA):</p> <table border="1" data-bbox="391 1419 561 1514"> <tr><td>1/16" (1,5 mm)</td></tr> <tr><td>1/32" (0,8 mm)</td></tr> <tr><td>1/4" (6,4 mm),</td></tr> <tr><td>3/16" (4,8 mm)</td></tr> </table>	1/16" (1,5 mm)	1/32" (0,8 mm)	1/4" (6,4 mm),	3/16" (4,8 mm)		<p>stinga</p>	2,5 €
1/16" (1,5 mm)								
1/32" (0,8 mm)								
1/4" (6,4 mm),								
3/16" (4,8 mm)								
TCR	<p>PICIORUS COMPENSATOR DIN TEFLON (DREAPTA):</p> <table border="1" data-bbox="391 1776 561 1871"> <tr><td>1/16" (1,5mm)</td></tr> <tr><td>1/32" (0,8mm)</td></tr> <tr><td>1/4" (6,4mm),</td></tr> <tr><td>3/16" (4,8mm)</td></tr> </table>	1/16" (1,5mm)	1/32" (0,8mm)	1/4" (6,4mm),	3/16" (4,8mm)		<p>dreapta</p>	2,5 €
1/16" (1,5mm)								
1/32" (0,8mm)								
1/4" (6,4mm),								
3/16" (4,8mm)								

NT-23

PICIORUS TEFLON pentru colturi



1 €

TFL-B-0,5 mm
TFL-B-1 mm
TFL-B-1,5 mm

BANDA TEFLON CU GROSIME de (lungime 1 ml) pentru lipit pe picioruse de diferite grosimi
0,5 mm
1 mm
1,5 mm

11 €

Picioruse pentru masina cu transport la ac

cod

denumire

Pret € + TVA

cod	denumire
21R-NF	PICIORUS COMPENSATOR DREAPTA pentru masina cu transport la ac Distanța de 0 mm
211R-NF	Distanța de 1 mm
212R-NF	Distanța de 2 mm
213R-NF	Distanța de 3 mm
214R-NF	Distanța de 4 mm
215R-NF	Distanța de 5 mm



stinga

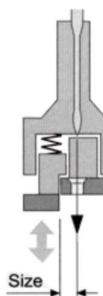

12 €

cod	denumire
22L-NF	PICIORUS COMPENSATOR STINGA pentru masina cu transport la ac Distanța de 0 mm
221L-NF	Distanța de 1 mm
222L-NF	Distanța de 2 mm
223L-NF	Distanța de 3 mm
224L-NF	Distanța de 4 mm
225L-NF	Distanța de 5 mm



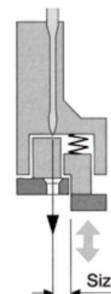

dreapta



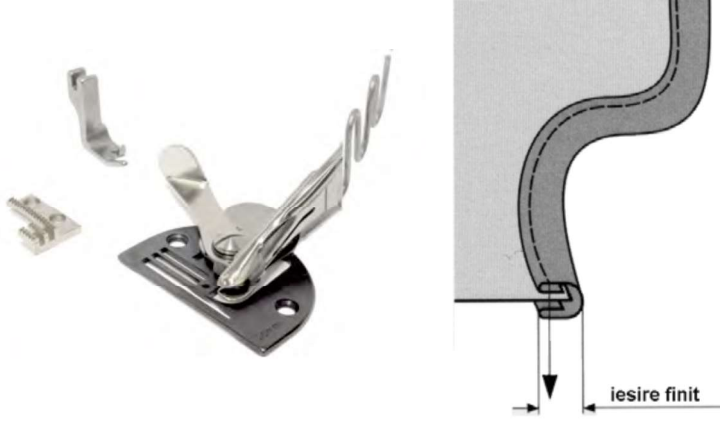

12 €

Dispozitive

Dispozitive de passpoil

cod	denumire	Pret € + TVA																																
A10	DISPOZITIV EINFASS:	 <p>8 €</p>																																
	<table border="1"> <thead> <tr> <th>Intrare banda mm</th> <th>Iesire banda mm</th> </tr> </thead> <tbody> <tr><td>16 mm</td><td>4 mm</td></tr> <tr><td>18 mm</td><td>4,5 mm</td></tr> <tr><td>20 mm</td><td>5 mm</td></tr> <tr><td>22 mm</td><td>5,5 mm</td></tr> <tr><td>24 mm</td><td>6 mm</td></tr> <tr><td>26 mm</td><td>6,5 mm</td></tr> <tr><td>28 mm</td><td>7 mm</td></tr> <tr><td>30 mm</td><td>8 mm</td></tr> <tr><td>32 mm</td><td>8,5 mm</td></tr> <tr><td>34 mm</td><td>9,5 mm</td></tr> <tr><td>36 mm</td><td>10 mm</td></tr> <tr><td>38 mm</td><td>10,5 mm</td></tr> <tr><td>40 mm</td><td>12 mm</td></tr> <tr><td>45 mm</td><td>13 mm</td></tr> <tr><td>50 mm</td><td>16 mm</td></tr> </tbody> </table>		Intrare banda mm	Iesire banda mm	16 mm	4 mm	18 mm	4,5 mm	20 mm	5 mm	22 mm	5,5 mm	24 mm	6 mm	26 mm	6,5 mm	28 mm	7 mm	30 mm	8 mm	32 mm	8,5 mm	34 mm	9,5 mm	36 mm	10 mm	38 mm	10,5 mm	40 mm	12 mm	45 mm	13 mm	50 mm	16 mm
	Intrare banda mm		Iesire banda mm																															
	16 mm		4 mm																															
	18 mm		4,5 mm																															
	20 mm		5 mm																															
	22 mm		5,5 mm																															
	24 mm		6 mm																															
	26 mm		6,5 mm																															
	28 mm		7 mm																															
	30 mm		8 mm																															
	32 mm		8,5 mm																															
	34 mm		9,5 mm																															
	36 mm		10 mm																															
38 mm	10,5 mm																																	
40 mm	12 mm																																	
45 mm	13 mm																																	
50 mm	16 mm																																	
A21	PICIORUS de aplicat passpoil cu :	 <p>20 €</p>																																
	<table border="1"> <thead> <tr> <th>Intrare mm</th> <th>Iesire mm</th> </tr> </thead> <tbody> <tr><td>13 mm</td><td>2,5 mm</td></tr> <tr><td>20 mm</td><td>4 mm</td></tr> <tr><td>26 mm</td><td>5 mm</td></tr> </tbody> </table>		Intrare mm	Iesire mm	13 mm	2,5 mm	20 mm	4 mm	26 mm	5 mm																								
	Intrare mm		Iesire mm																															
	13 mm		2,5 mm																															
20 mm	4 mm																																	
26 mm	5 mm																																	
A4(3/8") (1") (1/2") (3/4")	DISPOZITIV aplicat BANDA preformata cu latimea de 9,5mm (3/8")	 <p>10 €</p>																																

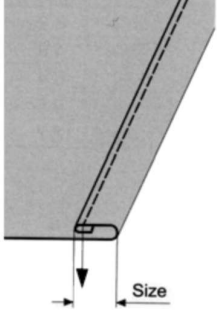
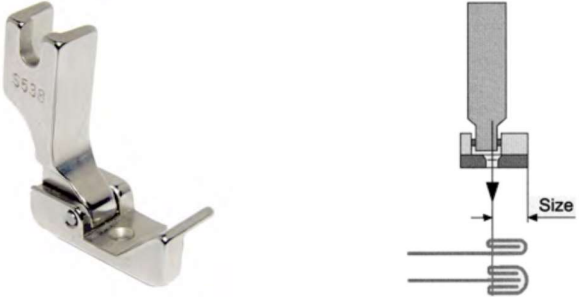
Dispozitive pentru tivuri

cod	denumire	Pret € + TVA																					
A11	<p>DISPOZITIV TIVITOR RABATABIL INTOARCERE DUBLA:</p> <table border="1" data-bbox="326 537 630 701"> <tr><td>3,2 mm</td><td>18 mm</td><td>32 mm</td></tr> <tr><td>4,8 mm</td><td>19 mm</td><td>35 mm</td></tr> <tr><td>6,4 mm</td><td>20 mm</td><td>40 mm</td></tr> <tr><td>8 mm</td><td>22 mm</td><td>45 mm</td></tr> <tr><td>10 mm</td><td>25 mm</td><td>50 mm</td></tr> <tr><td>13 mm</td><td>28 mm</td><td></td></tr> <tr><td>15 mm</td><td>30 mm</td><td></td></tr> </table> <p>Nota: se recomanda utilizarea dispozitivului impreuna cu piciorusul P3811, P3819 sau P3825!</p>	3,2 mm	18 mm	32 mm	4,8 mm	19 mm	35 mm	6,4 mm	20 mm	40 mm	8 mm	22 mm	45 mm	10 mm	25 mm	50 mm	13 mm	28 mm		15 mm	30 mm		 <p>5 €</p>
3,2 mm	18 mm	32 mm																					
4,8 mm	19 mm	35 mm																					
6,4 mm	20 mm	40 mm																					
8 mm	22 mm	45 mm																					
10 mm	25 mm	50 mm																					
13 mm	28 mm																						
15 mm	30 mm																						
P3811	<p>PICIORUS ingust cu ghidaj fix cu latimea talpii de 10mm</p>	 <p>4 €</p>																					
P3819	<p>PICIORUS cu ghidaj fix cu latimea talpii de 18mm</p>	 <p>4 €</p>																					
P3825	<p>PICIORUS lat cu ghidaj fix cu latimea talpii de 24mm</p>	 <p>4 €</p>																					

A13

**DISPOZITIV TIVITOR 2
CAPETE pentru 2 latimi
tivuri:**
1/8"-1/4" (3,2 mm-6,4 mm),
1/8"-3/16" (3,2 mm-4,8 mm)
Nota: se recomanda utilizarea
dispozitivului impreuna cu
piciorusul P3811, P3819 sau
P3825!

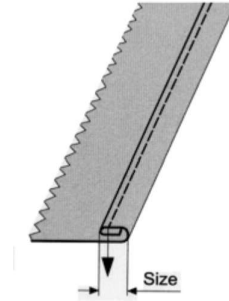

9 €

A70

**DISPOZITIV SET TIVITOR
CU BILA (set complet
dispozitiv rabatabil, piciorus
si transportor) cu piciorus:**
1/16" (1,5 mm)
1/8" (3,2 mm)
3/16" (4,8 mm)
1/4" (6,4 mm)
3/8" (9,5 mm)
1/2" (12,5 mm)

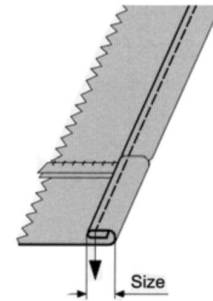

12 €

A450

**DISPOZITIV TIVITOR FIX
si INTOARCERE DUBLA**
1/16" (1,5 mm)
1/8" (3,2 mm)
3/16" (4,8 mm)
1/4" (6,4 mm)

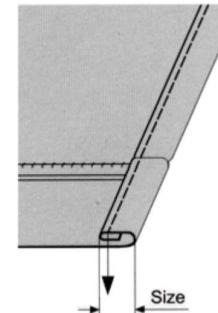

8 €

A75D

**DISPOZITIV TIVITOR
(margine simplu intoarsa
in jos):**
1/8"(3,2 mm)
3/8"(9,5 mm)
1/4"(6,4 mm)

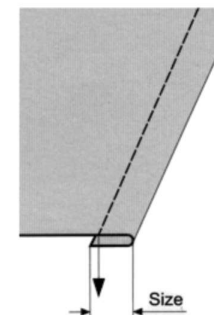

6 €

A75U

DISPOZITIV TIVITOR
(margine simplu intoarsa in sus):

1/8" (3.2 mm)
3/8" (9.5 mm)
1/4" (6.4 mm)
1/2" (12.7 mm)

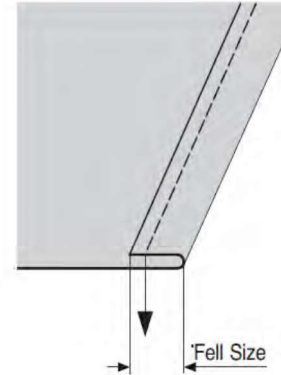

6 €

"1"
"2"
"3"
"4"
"5"
"6"
"7"
"9"

PICIORUS TIVITOR cu intoarcere dubla:

1	1,6 mm = 1/16"
2	2,4 mm = 3/32"
3	4 mm = 5/32"
4	4,8 mm = 3/16"
5	5,6 mm = 7/32"
6	6,4 mm = 1/4"
7	8 mm = 5/16"
9	9,5 mm = 3/8"

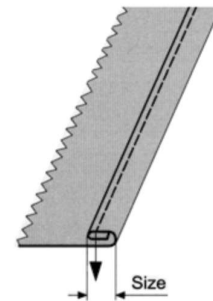

5,5 €

H5017

PICIORUS TIVITOR
(margine simplu intoarsa):

1/4" (6,4mm)
3/16" (4,8mm)

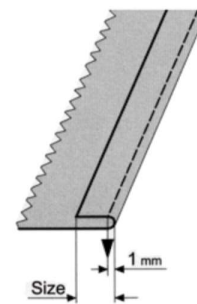

11 €

H5018

PICIORUS TIVITOR CU GHIDAJ cu intoarcere dubla:

1/4" (6,4 mm)
3/16" (4,8 mm)
1/32" (0,8 mm)
1/8" (3,2 mm)

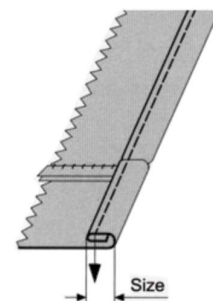

12 €

H5019(1/4")
PICIORUS TIVITOR
(margine simplu intoarsa)
6,4mm (1/4")

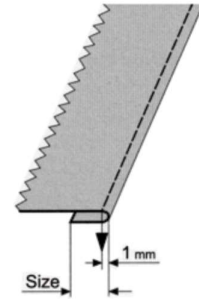

11 €

H5020(1/4")
PICIORUS ASAMBLAT 2
PARTI cu rezerva de
coasere:
6,4mm (1/4")
4,8mm(3/16")

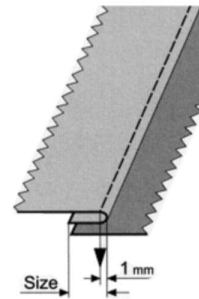
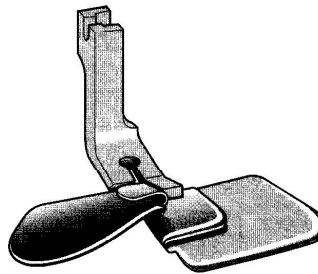





17 €

Dispozitive pentru aplicat vipusca si snur

cod	denumire		Pret € + TVA															
A46A	DISPOZITIV VIPUSCA cu sau fara SNUR intrare banda de 20mm sau 25mm (latime vipusca reglabila functie de rezerva de coasere)		 15 €															
A20	PICIORUS de aplicat vipusca cu sau fara introducere SNUR: <table border="1" data-bbox="354 936 678 1146"> <thead> <tr> <th>Intrare banda mm</th> <th>iesire vipusca cu snur mm</th> <th>iesire vipusca fara snur mm</th> </tr> </thead> <tbody> <tr> <td>16 mm</td> <td>6 mm</td> <td>8 mm</td> </tr> <tr> <td>20 mm</td> <td>8 mm</td> <td>10 mm</td> </tr> <tr> <td>24 mm</td> <td>10 mm</td> <td>12 mm</td> </tr> <tr> <td>30 mm</td> <td>13 mm</td> <td>15 mm</td> </tr> </tbody> </table>	Intrare banda mm	iesire vipusca cu snur mm	iesire vipusca fara snur mm	16 mm	6 mm	8 mm	20 mm	8 mm	10 mm	24 mm	10 mm	12 mm	30 mm	13 mm	15 mm		 20 €
Intrare banda mm	iesire vipusca cu snur mm	iesire vipusca fara snur mm																
16 mm	6 mm	8 mm																
20 mm	8 mm	10 mm																
24 mm	10 mm	12 mm																
30 mm	13 mm	15 mm																





Dispozitive tip "Spaghetti"

cod	denumire		Pret € + TVA
MS53(5/8")	DISPOZITIV "SPAGHETTI" (snur fara cusatura pe fata) prin simpla intrare banda 15,87mm (5/8") iesire snur 4 mm		 75 €
S53(5/8")	DISPOZITIV "SPAGHETTI" pentru masina simpla cu intrare banda 5/8" (15,87 mm) cu iesire snur fara cusatura pe fata de 3 mm		 75 €

Limitatoare

cod	denumire		Pret € + TVA
G1	LIMITATOR FIX "T"		1 €
G30-M	LIMITATOR CUSUT TIP ROLA / CUSATURI CURBE		4 €
G4	LIMITATOR PENTRU CAMASI		2 €
G7	LIMITATOR RABATABIL		2 €
G8	LIMITATOR CU 3 PARTI		2 €
G20	LIMITATOR MAGNETIC		1,5 €

Accesorii

cod	denumire		Pret € + TVA
AP18E	TAIETOR MANUAL DE FIR CU ARC SI CUTIT	  <p>Se monteaza in spatele piciorusului!</p>	1 €
218TM	CENTIMETRU (60" sau 152cm)		1 €
8H-HSS	LAMA TAIERE pentru masina de croit cu lama 8" (HITAKA 8")		4 €
TC800	FOARFECA		1 €
S01943-001	SURUBELNITA cu cap imbus		1,5 €

Masina de cusut tip Uberdeck (B271, 272)

A36

**DISPOZITIV GAICI
UBERDECK (fara
pretaiere)**

Final gaica mm	Intrare gaica mm
10 mm	20 mm
12 mm	24 mm
15 mm	30 mm

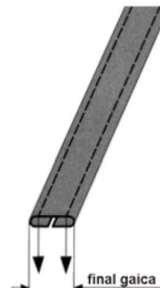

10 €

**DISPOZITIV BENTITA simplu preformata
pentru masina de uberdeck cu decupare**

S123A

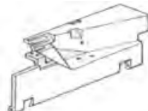

Intrare banda mm	iesire banda mm
20 mm	6,4 mm
35 mm	8 mm
32 mm	12 mm
42 mm	16 mm
45 mm	17,5 mm
48 mm	19 mm
55 mm	22,2 mm
60 mm	25 mm
70 mm	30 mm

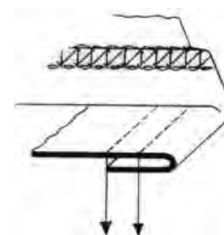

14 €

**DISPOZITIV BENTITA
dublu preformata pentru
masina de uberdeck cu
decupare:**

S123B

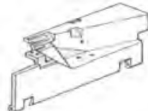

Intrare banda mm	iesire banda mm
25 mm	6,4 mm
30 mm	8 mm
32 mm	8 mm
44 mm	14 mm
65 mm	22 mm
70 mm	25 mm
85 mm	32 mm

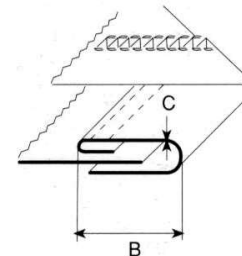

13 €

**Optional:
Sistem prindere pentru
123A si 123B compus
din:**

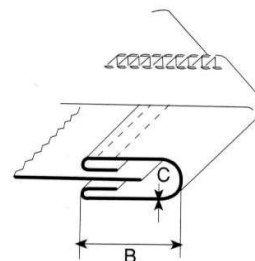

13 €

S09004-001 – ruler setting base

**S09004-001
S09005-001**



DISPOZITIV BENTITA simplu preformata cu baza de fixare pentru masina de uberdeck standard:

S124A

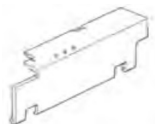

Intrare banda mm	lesire banda mm
19 mm	6,4 mm
25 mm	8 mm
35 mm	12,7 mm
40 mm	16 mm
45 mm	17,5 mm
48 mm	19 mm
60 mm	25 mm
65 mm	22 mm
66 mm	30 mm
75 mm	32 mm

S09005-001 – ruller setting plate



9 €

DISPOZITIV BENTITA dublu preformata cu baza de fixare pentru masina de uberdeck standard:

S124B

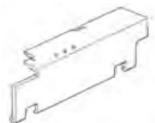

Intrare banda mm	lesire banda mm
25 mm	6,4 mm
32 mm	8 mm
65 mm	22 mm
70 mm	25 mm

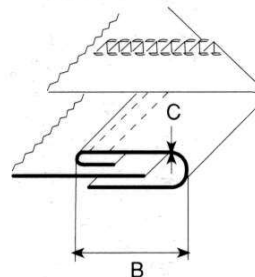

15 €

B272-011-6 H

SET
CONVERSI
E
UBERDECK
3 ACE 4,8
mm

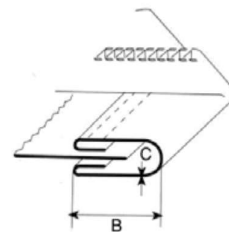

15 €

B272-011-7 H

SET CONVERSIE UBERDECK 3 ACE 5,6 mm

B272-011-8 H

SET CONVERSIE UBERDECK 3 ACE 6,4 mm



70 €

B272-031-6 H

SET CONVERSIE UBERDECK APLATIZARE
3 ACE 4,8 mm









B272-031-7 H
SET CONVERSIE UBERDECK APLATIZARE
3 ACE 5,6mm

B272-031-8 H
SET CONVERSIE UBERDECK APLATIZARE
3 ACE 6,4 mm

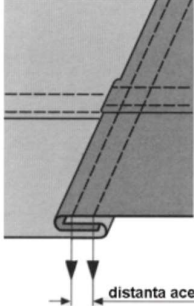

90 €

Masina de cusut cu 2 ace cusatura rigida (B842, B845)

A31(1/4M)	<p>DISPOZITIV CUSATURA FRANTUZEASCA pentru masina cu 2 ace cusatura rigida (B842, B845) cu distanta dintre ace de 1/4" (6,4mm)</p>			24 €
MS112(1/4")	<p>PICIORUS de aplicat BANDA adidas la masina cu 2 ace latimea benzii la intrare de 20mm si la iesire de 10mm</p>			15 €
MT-260(1/4")	<p>PICIORUS TEFLON pentru masina cu 2 ace cu distanta de 1/4" (6,4mm)</p>			2,5 €
<p>B845-5 H SET CONVERSIE 2 ACE ESCAMOTABILE (va rugam sa specificati distanta!)</p>				35 €
<p>B842-3 (3/16"-4,8 mm) H SET CONVERSIE 2 ACE (va rugam sa specificati distanta!)</p>				35 €

Masina de cusut cu brat pentru cusatura frantuzeasca (B927)

A30

**DISPOZITIV CUSATURA
FRANTUZEASCA BRAT**
cu 2 ACE (B925, B927):
1/4" (6,4mm),
3/16" (4,8mm)

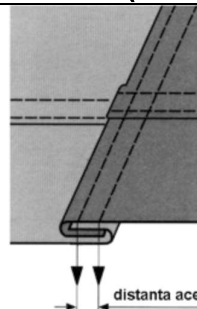

13 €

Masina cu 4 ace pentru betelie (B281)

K411(30M)

**DISPOZITIV de
preformare betelie si
introducere elastic la
masina cu 4 ace (B281)**
30MM

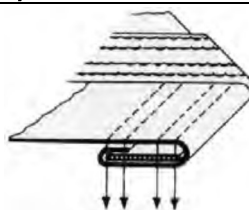

75 €

Masina de surfilat (Seria N)

N31-63-5 H

SET conversie TRIPLOCK 5 FIRE (3X5)



90 €

N31-65-5 H

SET conversie TRIPLOCK 5 FIRE (5X5)

Ace de cusut Groz-Beckert

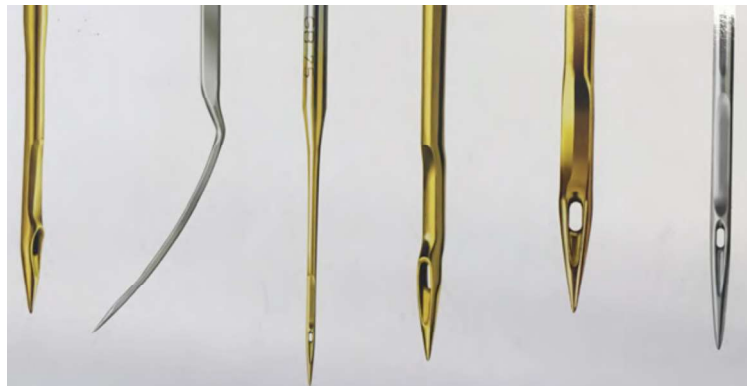

Cod ace	pret bucata EURO fara TVA	pret 1000 bucati EURO fara TVA
134 masina liniara	0,0975	97,5
134 GEBEDUR masina liniara din titan aurit	0,13065	130,65
B 27 masina de surfilat	0,16638	166,38
B27 GEBEDUR masina de surfilat din titan aurit	0,22295	222,95
B63 masina de acoperire	0,16638	166,38
B63 GEBEDUR masina de acoperire din titan aurit	0,22295	222,95
1985 masina de cusut nasturi	0,13388	133,88
DBXK5 masina de brodat	0,0975	97,5
LWX6T masina de cusut stafir	0,57463	574,63

SISTEMELE DE AC SUNT DISPONIBILE IN VARIANTELE:

- bila mica pentru materiale sintetice sau tricotate
- bila mare pentru materiale cu elastomeri

Ulei pentru masini de cusut

**Ulei special pentru masini de cusut 2,9 €+TVA/litru
OBI 13/AGIP**

Viscozitate la 40°C: 16-18,7 mm²/s

Ambalaj standard 21 litri: bidon metal



Consumabile pentru sala de CROIT

Lame bandzig diferite dimensiuni
Cutite verticale si cutite circulare
Origine Germania, Producator BS si Maier Unitas



Piese de schimb si consumabile pentru mese de calcat si generatoare

descriere		cod	pret eur/buc fara tva
Fier electric vaporizant 1,5 kg STAR P cu rezistenta incorporate in talpa		1001	61
Fier electric vaporizant 2 kg F1 cu rezistenta detasabila		1007	77
Termostat Bimet		1206	5,49
Termostat Tulipano		1203	4,6
Rezistenta fier 800W		1301	17

Rezistentă 3/8" 2000W (Pony, Comel, Silc)
diametru: 55 mm



2102 27,04

Rezistentă 3/8" 3300W generator (Pony,
Campel, Ghidini, Comel, Trevil, Stirovap,
Casoli, Reverberi, etc)



2109 36

Rezistentă 1-1/4" 2500W Batistela



2120 20

Talpa □eflon F1

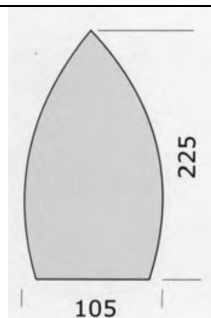

1601 9

Talpa □eflon F2

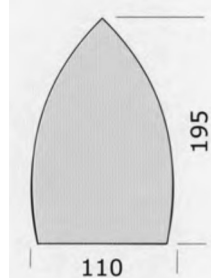

1602 9

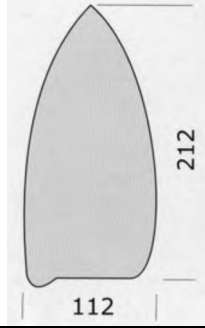
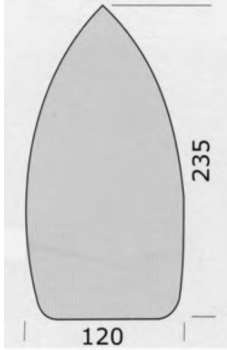
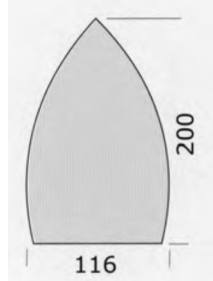

Talpa teflon Veit HD 2000		1632	9
Talpa teflon Maxi Lemm		1622	9
Talpa teflon Ironmaster		1604	9
Pasta de curatat fier Stick		1709	1,9
Stut Fier 1/8		1705	1,58
Cablu electric 4 fire siliconic		1701	2
Tub vapori siliconic		1703	2
Electroventil SAMA 150/R ¼"		2008	23
Bobina Electroventil SAMA N1500		2003	11,2
Nucleu Electroventil CEME		2015	8,16
Canota Electroventil CEME		2017	14,79
Nucleu Electroventil SAMA		2018	5,1
Canota Electroventil SAMA		2020	10,96
Nucleu teflon Electroventil CEME		2021	6,6
Stut Electroventil Sirai 3/8"		2029	0,79
Pompa PEDROLLO PQM 60 -220V, 1/50 0,5 CP, 1"-1", max. 4 bar – 10 lt/min		2407	75
Turbina pompa PQM 70-PQ70		2414	8,7
Presetupa Pompa PQM 60-PQM70		2420	3,57
Solutie curatat generator		2632	30,6
Husa fodera strech verde, l=150 cm		3001	5,64

Husa terylene albastra, l=150 cm	3002	8,16
Rezistentă masa 800W	3128	19
Tub flexibil inox ½"	4004	21
Niplu conic 3/8-1/2"	4016	2,2
Tub aspiratie diam. 60 mm D3100	4033	16,6
Izolatie metalica diametru 22 mm	4201	1,18
Oala condens TD 52 ½"	4302	78
Oala condens cap coloana ½" 8 bar	4301	96
Supapa sens (3/8", ½", ¾", 1") F2000	4314	4,04
Robinet bila ½"	4319	0,25
Regulator electronic PLUTONE 2200	4440	45
Regulator presiune ½"; 3,5÷6 bar	4338	415,86
Tub racord PTFE L=1.800 diam 6 D1000	4041	22,25
Presostat Mater Dampf 2-6 bar	2209	23,24
Presostat Ceme cilindric ¼ 2-6 bar	2202	14
Microintrerupator pedala MS 05 masa	3301	6,12
Microintrerupator MS 09	3302	7,7
Microintrerupator Elbi masa	3309	7,91

Lampi de iluminat local cu LED

model		pret eur/buc fara tva
<p>Model: DS-10DH Putere: 0.5W Voltaj: AC 100-240V 380V Se leaga la motorul masinii Se poate aplica pe orice model de masina Nota: Utilizeaza noul concept ultraperformant SMD-LED si prindere magnetica. Iluminarea unghiului de lucru se face din ambele parti ale acului, astfel nu se creaza umbre</p>	 <p>DS-10DH-D Three Levels Dimming Power-Supply is available</p>	12 €
<p>Model: DS-6U Putere: 0.5W Voltaj: AC 100-240V 380V Se leaga la motorul masinii Se poate aplica pe orice model de masina Nota: Utilizeaza noul concept ultraperformant SMD-LED si prindere magnetica. Iluminarea unghiului de lucru se face din ambele parti ale acului, astfel nu se creaza umbre.</p>	 <p>DS-6U-D Three Levels Dimming Power-Supply is available</p>	12 €
<p>Model: DS-1K Putere: 2W Voltaj: AC 100-240V Se leaga la motorul masinii, priza Se poate aplica pe orice model de masina Nota: Utilizeaza noul concept ultraperformant COB-LED, 5 nivele de luminozitate ajustabila cu functie de memorie si sistemul ultraperformant de prindere magnetica.</p>		15 €

LASERE

model		pret eur/buc fara tva
<p>DS-1 LASER PUNCT Putere: 0.5W Voltaj: AC 100-240V Se leaga la motorul masinii Nota: Focus ajustabil Aplicatii uzuale: masina de cusut nasturi</p>		12 €
<p>DS-1S LASER CRUCE Putere: 0.5W Voltaj: AC 100-240V Se leaga la motorul masinii Lungime raza: 0.01-1m Distanța lampa fata de punctul de coasere=1:0.15 Aplicatii uzuale: masina de brodat</p>		12 €
<p>DS-1L LASER LINIE Putere: 0.5W Voltaj: AC 100-240V Se leaga la motorul masinii Lungime raza: 1-4m Distanța lampa fata depunctul de coasere=1:1 Aplicatii uzuale: masina de taiat</p>		12 €

Livrăm la comandă și din stoc (peste **100.000** de repere) piese originale pentru următoarele mărci de mașini:



BROTHER - Mașini industriale de cusut și brodat

<http://partsbook.brother.co.jp/partsnavi/eng/index.html>



PEGASUS - Mașini de surfilat, de acoperire, cusătură lanț

<http://www.pegasus-europa.de/pp-catalogues.htm>



KANSAI SPECIAL - Mașini cusătură lanț, special, multi-ace

<http://www.kansai-special.de/Home/index.php/>

<http://www.kansai-special.co.uk>

http://www.kansai-special.com/english/prod/prod_info.html



BARUDAN - Mașini industriale de brodat

<http://barudan.fr/en/> <http://barudan.fr/en/telechargements/>



A-S-S AUTOMATIC SEWING SYSTEMS - Automate de coasere

http://assag.de/start_eng



MAIER UNITAS - Mașini de cusut ștafir și piese de schimb

<http://www.maier-unitas.de/95-1-Rumaenien.html>



COMPLETT - Ketturi și mașini cusătură punct manual

<http://complett.it/en/index.html>

ALTE MĂRCI: **BATTISTELLA** BS **CCEA** CERLIANI **EFKA** HIROSE HOOKS
JUKI MERROW **RELIANT** SIRUBA **YAMATO** Z LASER

PIESE DE SCHIMB: Carmen **MAIL:** piese@brorom.ro **TELEFON:** (+4) 0751-020.959

www.brorom.ro

BRO ROM Industrial Machines srl

Str. Uranus nr. 150, sector 5, Cod 050826, București - Romania

TELEFON / Fax: (+4) 021-232.38.72, (+4) 021 232.38.44, (+4) 021-232.98.93

MOBIL (+4) 0751-888.444

PIESE DE SCHIMB piese@brorom.ro - Carmen 0751-020.959

MAȘINI INDUSTRIALE office@brorom.ro - Bogdan 0722-334.990

MAȘINI CASNICE DE CUSUT ȘI BRODAT info@cusutsibrodat.ro - Dan 0722-293.132

În incinta clădirii THE ARK



Mașini de cusut și mașini de brodat industriale, utilaje pentru croit și CAD, mese și prese de călcat, generatoare de abur, prese de termocolat, utilaje speciale, automate de coasere, software, piese de schimb, accesorii, dispozitive, service, consultanță, suport tehnic, know-how.

Reprezentant autorizat al **BROTHER** Internationale Industriemaschinen GmbH

www.brorom.ro